

TM315B60 Drum Motor (matching Idler KT315B60**)

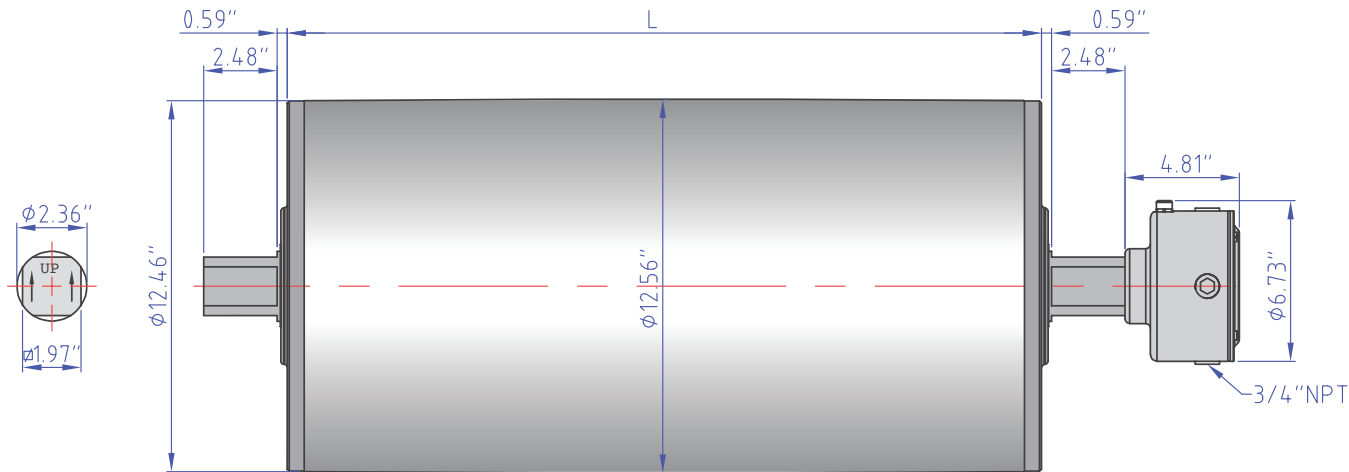

Standard drum motor face widths* (L) in inches:

25.59	27.56	29.53	31.50	33.46	35.43	37.40	39.37	41.34	43.31	45.28	47.24	49.21
51.18	53.15	55.12	57.09	59.06	61.02	62.99	64.96	66.93	68.90	70.87	72.83	74.80

*Some face widths are not available in all horsepower. For minimum available face widths: [Click Here to View Chart.](#)

**Idler dimensions are identical to the drum motor with no junction box.

Brackets: 315-AB-60

